

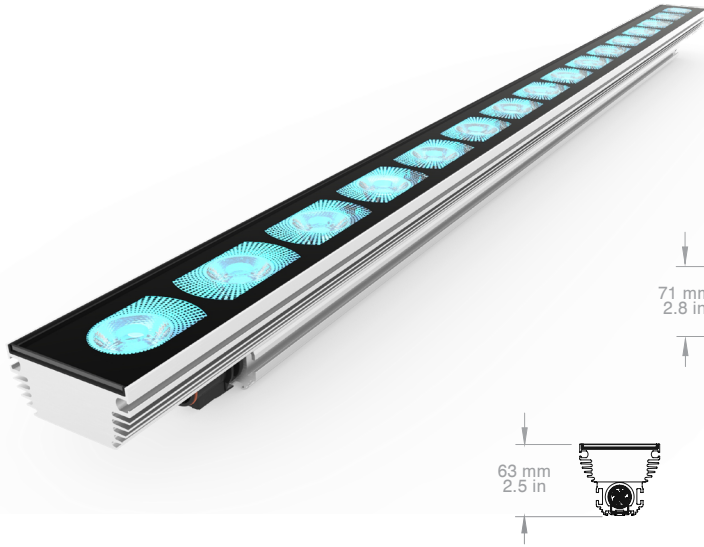

Color Changing Linear Wall Washing and Grazing LED Lighting

PRODUCT SPECIFICATION SHEET



DATE: _____

TYPE: _____

COMPANY: _____

PROJECT: _____

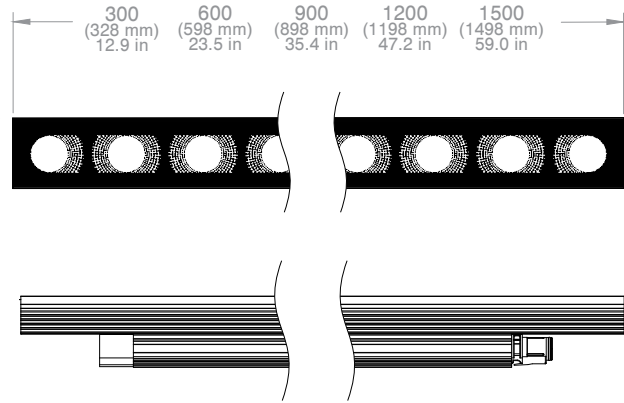

FEATURES:

Lighting Performance:

- Up to 2040 lumens/meter (626 lumens/foot)
- COLOR-AMP[®] technology allows up to three times higher light output in specific colors
- Outstanding color mixing (no striations or colour separation)
- Homogenous light output immediately adjacent to luminaire
- LED pitch is maintained within and between luminaires (no dark spots between fixtures)
- Color match with FL Series

Mechanical Details:

- Compact size, only 63 mm (2.5 in) high x 71 mm (2.8 in) wide
- IP66 rated with proprietary sealing process and solid extruded, anodized aluminum UNIBODY™ design
- Electronic micro leak detection test performed for each hermetically sealed fixture
- Meets 3G ANSI C136.31-2010 Vibration Standard for Bridge and Overpass Applications
- Optically clear tempered glass lens (no yellowing over time)
- Guaranteed long life time and high performance, no electrolytic capacitors in all DC designs
- Through wiring for end-to-end connection via snap-in and lock connectors
- IK06 rated fixture body construction, IK10 accessories available upon request¹

Control:

- DMX control through GVA's power-data equipment
- 300mm resolution, each 300mm section can be addressed individually, self-addressing fixtures

Projected Lifetime: L70 > 65,000hrs @ t₅₀ = 50°C (122°F)

Operating Temperatures: -40°C to +50°C (-40°F to 122°F)

OPTIONS:

Power Source: 48VDC, 120VAC, 220-240VAC, 277VAC, 380VDC

Power Options: 10W, 15W or 20W per 300mm (1ft)

Nominal Length: 300mm (1ft), 600mm (2ft), 900mm (3ft), 1200mm (4ft) and 1500mm (5ft)

Beam Distribution: Range of symmetrical and elliptical beam angles available

Body Color: Black matte and clear matte anodized or custom color¹

Accessories:

- Adjustable and non-adjustable mounting brackets
- Glare control louvers

LED Color:

- Custom LED color combinations available

SPECIFICATION LOGIC: STR9 COLOR CHANGING

FAMILY	NOMINAL LENGTH	BODY COLOR	POWER per 300mm (1ft)	LED COLOR	OPTICS (FWHM)	INPUT VOLTAGE	OPTIONAL
STR9-G3	300 ²	CM - Clear Matte Anodized	10W	RGB	10 - 10° x 10° ³	ELV - 48VDC	NL - No Louver MLH - Micro Louver, Horizontal MLV - Micro Louver, Vertical
	600	BM - Black Matte Anodized	15W	RGBA	12 - 12° x 12°	AC - 120 to 277VAC	
	900		20W	RGBW30K	15 - 15°x15°	INF - 380VDC	
	1200				30 - 30°x30°		
	1500				60 - 60°x60° 80 - 80°x80° 10x30 - 10°x30° 10x60 - 10°x60° 30x60 - 30°x60°		
Other distributions available; Consult factory.							

PRODUCT CONFIGURATION

1. IK10 is not a standard configuration, some restrictions apply, please consult factory.
 2. Actual length of 328mm. Pitch not maintained.
 3. Custom configuration, some restrictions apply, please consult factory.



2022-01-06

Color Changing Linear Wall Washing and Grazing LED Lighting

PRODUCT SPECIFICATION SHEET

PRODUCT SPECIFICATIONS: STR9 COLOR CHANGING							
Nominal Length		300	600	900	1200	1500	
Electrical	Nominal Wattage	10W/ft	10W	20W	30W	40W	50W
		15W/ft	15W	30W	45W	60W	75W
		20W/ft	20W	40W	60W	75W	100W
	Power Consumption for 48VDC Input	10W/ft	12.7W	23.7W	34.3W	45.0W	56.1W
		15W/ft	18.0W	34.3W	50.6W	67.5W	84.3W
		20W/ft	23.7W	45.0W	67.5W	90.0W	112.7W
	Power Consumption for 120-277VAC Input	10W/ft	24W	34W	44W	54W	64W
		15W/ft	29W	44W	59W	74W	89W
		20W/ft	34W	54W	74W	94W	114W
Optical	Light Source	4 x High Power 4 in 1 LEDs per 300mm (1ft)					
	COLOR-AMP™ 10W Lumen Output (typical) ^{1,2}	Red	219 lm	438 lm	657 lm	876 lm	1,095 lm
		Green	286 lm	572 lm	858 lm	1,144 lm	1,430 lm
		Blue	99 lm	198 lm	297 lm	396 lm	495 lm
		Amber	169 lm	338 lm	507 lm	676 lm	845 lm
		White (3000K)	392 lm	784 lm	1,176 lm	1,568 lm	1,960 lm
		All on RGB	271 lm	542 lm	813 lm	1,084 lm	1,355 lm
		All on RGBA	276 lm	552 lm	828 lm	1,104 lm	1,380 lm
	All on RGBW30K	345 lm	690 lm	1,035 lm	1,380 lm	1,725 lm	
	COLOR-AMP™ 15W Lumen Output (typical) ^{1,2}	Red	228 lm	456 lm	684 lm	912 lm	1,140 lm
		Green	368 lm	736 lm	1,104 lm	1,472 lm	1,840 lm
		Blue	134 lm	268 lm	402 lm	536 lm	670 lm
		Amber	189 lm	378 lm	567 lm	756 lm	945 lm
		White (3000K)	495 lm	990 lm	1,485 lm	1,980 lm	2,475 lm
		All on RGB	371 lm	742 lm	1,113 lm	1,484 lm	1,855 lm
All on RGBA		385 lm	770 lm	1,155 lm	1,540 lm	1,925 lm	
All on RGBW30K	491 lm	982 lm	1,473 lm	1,964 lm	2,455 lm		
COLOR-AMP™ 20W Lumen Output (typical) ^{1,2}	Red	321 lm	642 lm	963 lm	1,284 lm	1,605 lm	
	Green	399 lm	798 lm	1,197 lm	1,596 lm	1,995 lm	
	Blue	139 lm	278 lm	417 lm	556 lm	695 lm	
	Amber	195 lm	390 lm	585 lm	780 lm	975 lm	
	White (3000K)	537 lm	1,074 lm	1,611 lm	2,148 lm	2,685 lm	
	All on RGB	442 lm	884 lm	1,326 lm	1,768 lm	2,210 lm	
	All on RGBA	447 lm	894 lm	1,341 lm	1,788 lm	2,235 lm	
All on RGBW30K	608 lm	1,216 lm	1,824 lm	2,432 lm	3,040 lm		
Projected Lumen Maintenance	L70 > 65,000hrs @ t _a = 50°C (122°F)						
Control	Control Protocol	DMX control through GVA's Power-Data Equipment, 300mm (1ft) resolutions					
Physical	Length	328 mm (12.9 in)	598 mm (23.54 in)	898 mm (35.35 in)	1,198 mm (47.17 in)	1,498 mm (58.98 in)	
	Width x Height	71 mm x 63 mm (2.8 in x 2.5 in)					
	Weight (ELV)	1.0 kg (2.2 lbs)	1.9 kg (4.2 lbs)	2.85 kg (6.28 lbs)	3.85 kg (8.5 lbs)	4.85 kg (10.7 lbs)	
	Weight (INF)		2 kg (4.4 lbs)	3 kg (6.6 lbs)	4 kg (8.8 lbs)	5 kg (11 lbs)	
	Weight (AC)		2 kg (4.4 lbs)	3 kg (6.6 lbs)	4 kg (8.8 lbs)	5 kg (11 lbs)	
	Housing & Lens	Aluminum Body and tempered flat glass lens, IK06 rated, Optional IK10					
Fixture Connections	IP68 sealed input and output connectors, with audible "click" snap-in & lock						
Temperature Ranges	Rated Operation Temperature	-40°C to +50°C (-22°F to 122°F)					
	Minimum Starting Temperature	-30°C (-22°F)					
	Storage Temperature	-40°C to +85°C (-22°F to 185°F)					
Certification & Safety	IES Classifications	Class 1 LED Luminaire					
	Certifications	<p>QPS (US Field Evaluation) or ETL (Special Electrical Equipment Inspection) where applicable CE Certified RoHS Compliant Constructed to meet requirements outlined in UL1598 & IEC60598 Meets ANSI C136.31, 3G Vibration standard for bridge and overpass applications Dry, damp, or wet locations, 0-100% humidity, IP66</p>					
	Environment	Dry, damp, or wet locations, 0-100% humidity, IP66					

1. Measurement data provided for 10 degree beam angle fixtures
 2. Please consult factory for most recent photometric data
 3. IK10 is not a standard configuration; consult factory

These figures are subject to change due to further development and innovations of LED light sources



Color Changing Linear Wall Washing and Grazing LED Lighting

PRODUCT SPECIFICATION SHEET

MAXIMUM RUN LENGTHS ¹								
		10W	15W	20W		10W	15W	20W
ELV	300	15.3 m	10.2 m	7.8 m		50.2 ft	33.5 ft	25.6 ft
	600	15.6 m	10.2 m	7.8 m		51.2 ft	33.5 ft	25.6 ft
	900	15.3 m	9.9 m	8.1 m		50.2 ft	32.5 ft	26.6 ft
	1200	15.6 m	10.8 m	7.2 m		51.2 ft	35.4 ft	23.6 ft
	1500	15.0 m	10.5 m	7.5 m		49.2 ft	34.4 ft	24.6 ft
120VAC	300	42.3 m	29.7 m	22.8 m		138.8 ft	97.4 ft	74.8 ft
	600	45.6 m	31.2 m	23.4 m		149.6 ft	102.4 ft	76.8 ft
	900	46.8 m	31.5 m	23.4 m		153.5 ft	103.3 ft	76.8 ft
	1200	46.8 m	31.2 m	24.0 m		153.5 ft	102.4 ft	78.7 ft
	1500	48.0 m	31.5 m	24.0 m		157.5 ft	103.3 ft	78.7 ft
240VAC	300	85.2 m	59.7 m	46.2 m		279.5 ft	195.9 ft	151.6 ft
	600	92.4 m	63.6 m	48.6 m		303.1 ft	208.7 ft	159.4 ft
	900	95.4 m	64.8 m	48.6 m		313.0 ft	212.6 ft	159.4 ft
	1200	97.2 m	64.8 m	48.0 m		318.9 ft	212.6 ft	157.5 ft
	1500	97.5 m	64.5 m	48.0 m		319.9 ft	211.6 ft	157.5 ft
277VAC ²	300	5.4 m	5.4 m	5.4 m		17.7 ft	17.7 ft	17.7 ft
	600	10.8 m	10.8 m	10.8 m		35.4 ft	35.4 ft	35.4 ft
	900	16.2 m	16.2 m	8.1 m		53.1 ft	53.1 ft	26.6 ft
	1200	21.6 m	10.8 m	10.8 m		70.9 ft	35.4 ft	35.4 ft
	1500	27.0 m	13.5 m	13.5 m		88.6 ft	44.3 ft	44.3 ft
INF ³	300	60.0 m	49.8 m	42.3 m		169.6 ft	163.4 ft	138.8 ft
	600	84.6 m	65.4 m	53.4 m		277.6 ft	214.6 ft	175.2 ft
	900	98.1 m	72.9 m	58.5 m		321.9 ft	239.2 ft	191.9 ft
	1200	106.8 m	78.0 m	61.2 m		350.4 ft	255.9ft	200.8 ft
	1500	112.5 m	81.0 m	63.0 m		369.1 ft	265.7 ft	206.7 ft

Ratings are for 30°C, de-rating will be used for higher ambient temperatures. Contact factory for applications support.

1. Run lengths may vary depending on luminaire length combination chosen. Please consult factory for layout configuration. Values calculated for 3 m leader cable and end to end configuration.

2. Type D breaker required for 277VAC

3. INF run length values determined using PS-INF-6000



2022-01-06

Color Changing Linear Wall Washing and Grazing LED Lighting

PRODUCT SPECIFICATION SHEET

ORDERING LOGIC: STR9 MOUNTING ACCESSORIES

WX - ADJUSTABLE WALL MOUNT BRACKET KIT

W40 ADJUSTABLE WALL MOUNT

PART NUMBER	COLOR	WEIGHT	
121128 121129	Clear Matte Anodized Black Matte Anodized	0.10 kg (0.21 lbs)	

W80 ADJUSTABLE WALL MOUNT

PART NUMBER	COLOR	WEIGHT	
121130 121131	Clear Matte Anodized Black Matte Anodized	0.12 kg (0.27 lbs)	

W130 ADJUSTABLE WALL MOUNT

PART NUMBER	COLOR	WEIGHT	
121132 121133	Clear Matte Anodized Black Matte Anodized	0.15 kg (0.32 lbs)	

W155 ADJUSTABLE WALL MOUNT

PART NUMBER	COLOR	WEIGHT	
121134 121135	Clear Matte Anodized Black Matte Anodized	0.16 kg (0.35 lbs)	

W180 ADJUSTABLE WALL MOUNT

PART NUMBER	COLOR	WEIGHT	
121136 121137	Clear Matte Anodized Black Matte Anodized	0.17 kg (0.38 lbs)	

SMA-I - INSIDE ADJUSTABLE SURFACE MOUNT BRACKET KIT

PART NUMBER	COLOR	WEIGHT	
121138 121139	Clear Matte Anodized Black Matte Anodized	0.09 kg (0.20 lbs)	

SMA-O - OUTSIDE ADJUSTABLE SURFACE MOUNT BRACKET KIT

PART NUMBER	COLOR	WEIGHT	
121825 121826	Clear Matte Anodized Black Matte Anodized	0.09 kg (0.20 lbs)	

SML - SURFACE MOUNT BRACKET KIT, NON-ADJUSTABLE

PART NUMBER	COLOR	WEIGHT	
121140 121141	Clear Matte Anodized Black Matte Anodized	0.08 kg (0.18 lbs)	



Color Changing Linear Wall Washing and Grazing LED Lighting

PRODUCT SPECIFICATION SHEET

ORDERING LOGIC: STR9 MOUNTING ACCESSORIES

CLP - CLIP MOUNT KIT, NON-ADJUSTABLE

PART NUMBER	COLOR	WEIGHT	
124859	STAINLESS STEEL	0.21 kg (0.47 lbs)	

MCD - CANTILEVER BRACKET, NON-ADJUSTABLE

PART NUMBER	COLOR	WEIGHT	
121146	STAINLESS STEEL	0.94 kg (2.08 lbs)	

CH - ADJUSTABLE HORIZONTAL CANTILEVER BRACKET KIT - 100 MM TO 500 MM

CM	BM	TYPE	WEIGHT	
123336	123355	CH-100	0.77 kg (1.69 lbs)	
123337	123356	CH-150	0.87 kg (1.92 lbs)	
123338	123357	CH-200	0.98 kg (2.16 lbs)	
123339	123358	CH-250	1.08 kg (2.39 lbs)	
123340	123359	CH-300	1.19 kg (2.62 lbs)	
123341	123360	CH-350	1.29 kg (2.85 lbs)	
123342	123361	CH-400	1.40 kg (3.08 lbs)	
123343	123362	CH-450	1.50 kg (3.31 lbs)	
123344	123363	CH-500	1.61 kg (3.54 lbs)	

*Surface mount fixture bracket not included, please order separately. Only 1 arm is shown, kit includes both arms.

CV - ADJUSTABLE VERTICAL CANTILEVER BRACKET KIT - 100 MM TO 500 MM

CM	BM	TYPE	WEIGHT	
123374	123393	CV-100	0.59 kg (1.30 lbs)	
123375	123394	CV-150	0.70 kg (1.53 lbs)	
123376	123395	CV-200	0.80 kg (1.77 lbs)	
123377	123396	CV-250	0.91 kg (2.00 lbs)	
123378	123397	CV-300	1.01 kg (2.23 lbs)	
123379	123398	CV-350	1.12 kg (2.46 lbs)	
123380	123399	CV-400	1.22 kg (2.69 lbs)	
123381	123400	CV-450	1.33 kg (2.92 lbs)	
123382	123401	CV-500	1.43 kg (3.15 lbs)	

*Surface mount fixture bracket not included, please order separately. Only 1 arm is shown, kit includes both arms.



ORDERING LOGIC: STR9 MOUNTING ACCESSORIES

CC - ADJUSTABLE CEILING MOUNT CANTILEVER BRACKET KIT - 100 MM TO 1000 MM

CM	BM	TYPE	WEIGHT
123766	123785	CC-100	0.62 kg (1.37 lbs)
123767	123786	CC-150	0.72 kg (1.60 lbs)
123768	123787	CC-200	0.83 kg (1.83 lbs)
123769	123788	CC-250	0.93 kg (2.06 lbs)
123770	123789	CC-300	1.04 kg (2.29 lbs)
123771	123790	CC-350	1.14 kg (2.52 lbs)
123772	123791	CC-400	1.25 kg (2.75 lbs)
123773	123792	CC-450	1.35 kg (2.98 lbs)
123774	123793	CC-500	1.46 kg (3.22 lbs)
123775	123794	CC-550	1.56 kg (3.45 lbs)
123776	123795	CC-600	1.67 kg (3.68 lbs)
123777	123796	CC-650	1.77 kg (3.91 lbs)
123778	123797	CC-700	1.88 kg (4.14 lbs)
123779	123798	CC-750	1.98 kg (4.37 lbs)
123780	123799	CC-800	2.09 kg (4.60 lbs)
123781	123800	CC-850	2.19 kg (4.83 lbs)
123782	123801	CC-900	2.30 kg (5.06 lbs)
123783	123802	CC-950	2.40 kg (5.30 lbs)
123784	123803	CC-1000	2.51 kg (5.53 lbs)

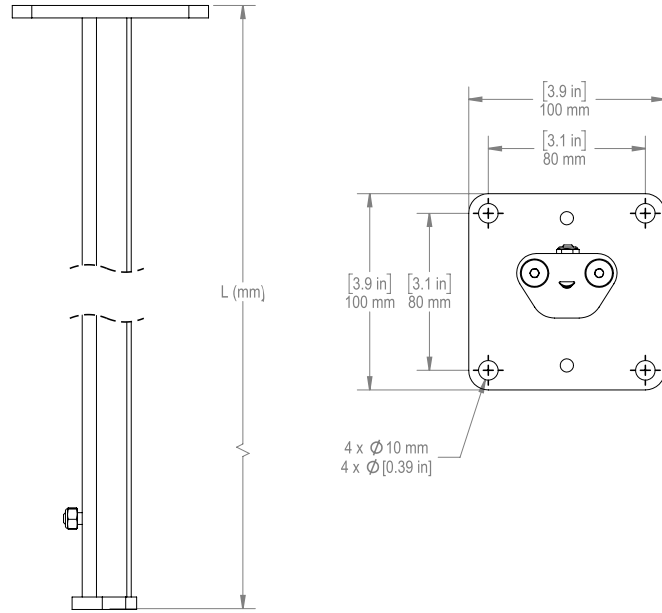

*Surface mount fixture bracket not included, please order separately. Only 1 arm is shown, kit includes both arms.

DCH - ADJUSTABLE HORIZONTAL DOUBLE CANTILEVER BRACKET KIT - 100 MM TO 500 MM

CM	BM	TYPE	WEIGHT
123709	123728	DCH-100	1.93 kg (4.25 lbs)
123710	123729	DCH-150	2.14 kg (4.71 lbs)
123711	123730	DCH-200	2.35 kg (5.17 lbs)
123712	123731	DCH-250	2.56 kg (5.63 lbs)
123713	123732	DCH-300	2.77 kg (6.10 lbs)
123714	123733	DCH-350	2.98 kg (6.56 lbs)
123715	123734	DCH-400	3.18 kg (7.02 lbs)
123716	123735	DCH-450	3.39 kg (7.48 lbs)
123717	123736	DCH-500	3.60 kg (7.95 lbs)

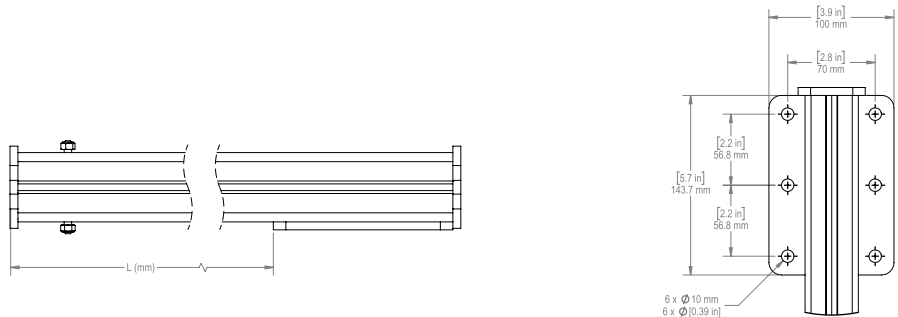

*Surface mount fixture bracket not included, please order separately. Only 1 arm is shown, kit includes both arms.



ORDERING LOGIC: STR9 MOUNTING ACCESSORIES

DCV-C - ADJUSTABLE VERTICAL & CEILING MOUNT DOUBLE CANTILEVER BRACKET KIT - 100 MM TO 500 MM

CM	BM	TYPE	WEIGHT
123628	123647	DCV-C-100	1.17 kg (2.57 lbs)
123629	123648	DCV-C-150	1.38 kg (3.04 lbs)
123630	123649	DCV-C-200	1.58 kg (3.50 lbs)
123631	123650	DCV-C-250	1.80 kg (3.96 lbs)
123632	123651	DCV-C-300	2.01 kg (4.42 lbs)
123633	123652	DCV-C-350	2.22 kg (4.88 lbs)
123634	123653	DCV-C-400	2.46 kg (5.35 lbs)
123635	123654	DCV-C-450	2.64 kg (5.81 lbs)
123636	123655	DCV-C-500	2.84 kg (6.27 lbs)

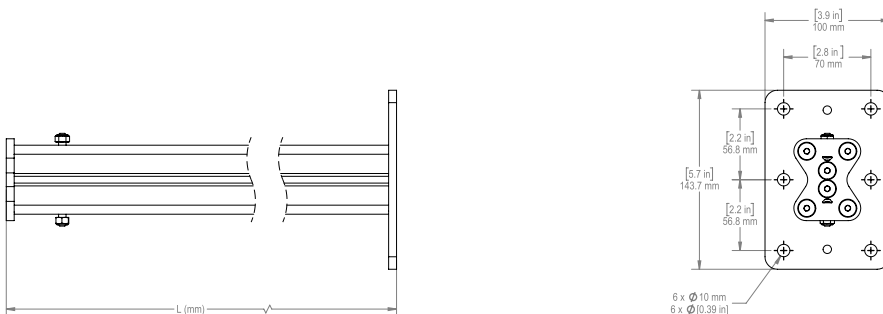

*Surface mount fixture bracket not included, please order separately. Only 1 arm is shown, kit includes both arms.

ANGLE ADJUSTMENT AND INSTALLATION TOOLS FOR SMA - ANGLES FROM 1° TO 20°

PART NUMBER	TYPE
310168	3°
310169	4°
310170	5°
310171	6°
310172	7°
310173	8°
310174	9°
310175	10°
310176	11°
310177	12°
310178	13°
310179	14°
310180	15°
310181	16°
310182	17°
310183	18°
310184	19°
310185	20°

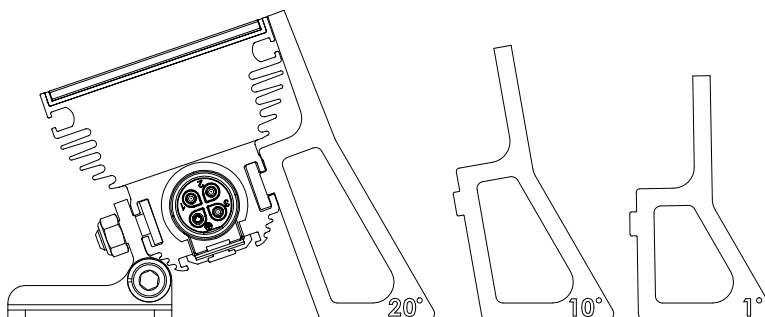



ORDERING LOGIC: COMMON COMPONENTS

STR9 LEADER CABLE ELV

PART NUMBER	NOMINAL LENGTH	WEIGHT	INPUT	OUTPUT
141481	3.0 m (9 ft)	420 g (0.93 lbs)		
141484	6.0 m (19 ft)	815 g (1.80 lbs)		
141487	9.0 m (30 ft)	1210 g (2.67 lbs)		
141489	15.0m (50 ft)	2000 g (4.41 lbs)		
141492	30.0 m (100 ft)	3975 g (8.76 lbs)		

STR9 REVERSE LEADER CABLE ELV (ONLY USED WITH PDR)

PART NUMBER	NOMINAL LENGTH	WEIGHT	INPUT	OUTPUT
142231	3.0 m (9 ft)	420 g (0.93 lbs)		
142234	6.0 m (19 ft)	815 g (1.80 lbs)		
142237	9.0 m (30 ft)	1210 g (2.67 lbs)		
142239	15.0m (50 ft)	2000 g (4.41 lbs)		
142242	30.0 m (100 ft)	3975 g (8.76 lbs)		

STR9 JUMPER CABLE ELV

PART NUMBER	NOMINAL LENGTH	WEIGHT	INPUT	OUTPUT
141603	END to END	105 g (0.23 lbs)		
141740	0.6 m (2 ft)	129 g (0.28 lbs)		
141741	0.9 m (3 ft)	169 g (0.37 lbs)		
141742	1.2 m (4 ft)	208 g (0.46 lbs)		
141743	1.5 m (5 ft)	248 g (0.55 lbs)		
141744	1.8 m (6 ft)	287 g (0.63 lbs)		
141758	6.0 m (20 ft)	840 g (1.85 lbs)		
141768	9.0 m (30 ft)	1235 g (2.72 lbs)		

*Not all jumper lengths are shown. Lengths available in 300mm increments. It is mandatory to include jumpers to connect STR9 GEN3 luminaires.

STR9 LEADER CABLE INF

PART NUMBER	NOMINAL LENGTH	WEIGHT	INPUT	OUTPUT
141495	3.0 m (9 ft)	420 g (0.93 lbs)		
141498	6.0 m (19 ft)	815 g (1.80 lbs)		
141501	9.0 m (30 ft)	1210 g (2.67 lbs)		
141503	15.0m (50 ft)	2000 g (4.41 lbs)		
141506	30.0 m (100 ft)	3975 g (8.76 lbs)		

STR9 REVERSE LEADER CABLE INF (ONLY USED WITH PDR)

PART NUMBER	NOMINAL LENGTH	WEIGHT	INPUT	OUTPUT
142201	3.0 m (9 ft)	420 g (0.93 lbs)		
142204	6.0 m (19 ft)	815 g (1.80 lbs)		
142207	9.0 m (30 ft)	1210 g (2.67 lbs)		
142209	15.0m (50 ft)	2000 g (4.41 lbs)		
142212	30.0 m (100 ft)	3975 g (8.76 lbs)		

STR9 LEADER CABLE AC

PART NUMBER	NOMINAL LENGTH	WEIGHT	INPUT	OUTPUT
141509	3.0 m (9 ft)	420 g (0.93 lbs)		
141512	6.0 m (19 ft)	815 g (1.80 lbs)		
141515	9.0 m (30 ft)	1210 g (2.67 lbs)		
141517	15.0m (50 ft)	2000 g (4.41 lbs)		
141520	30.0 m (100 ft)	3975 g (8.76 lbs)		

STR9 REVERSE LEADER CABLE AC (ONLY USED WITH PDR)

PART NUMBER	NOMINAL LENGTH	WEIGHT	INPUT	OUTPUT
142792	3.0 m (9 ft)	420 g (0.93 lbs)		
142795	6.0 m (19 ft)	815 g (1.80 lbs)		
142798	9.0 m (30 ft)	1210 g (2.67 lbs)		
142800	15.0m (50 ft)	2000 g (4.41 lbs)		
141803	30.0 m (100 ft)	3975 g (8.76 lbs)		

STR9 JUMPER CABLE INF & AC

PART NUMBER	NOMINAL LENGTH	WEIGHT	INPUT	OUTPUT
141602	END to END	105 g (0.23 lbs)		
141790	0.6 m (2 ft)	129 g (0.28 lbs)		
141791	0.9 m (3 ft)	169 g (0.37 lbs)		
141792	1.2 m (4 ft)	208 g (0.46 lbs)		
141793	1.5 m (5 ft)	248 g (0.55 lbs)		
141794	1.8 m (6 ft)	287 g (0.63 lbs)		
141808	6.0 m (20 ft)	840 g (1.85 lbs)		
141818	9.0 m (30 ft)	1235 g (2.72 lbs)		

*Not all jumper lengths are shown. Lengths available in 300mm increments. It is mandatory to include jumpers to connect STR9 GEN3 luminaires.



Color Changing Linear Wall Washing and Grazing LED Lighting

PRODUCT SPECIFICATION SHEET

ORDERING LOGIC: COMMON COMPONENTS

STR9 CABLE 3X14 AWG + 1X24 AWG

PART NUMBER	NOMINAL LENGTH	WEIGHT	
280253	Sold per m	132 g (0.291 lbs)	 <p>*Raw cable cut to length. Please specify required length.</p>

STR9 CONNECTOR CAP, IP67 (Must be used at the end of each run)

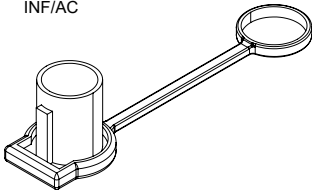
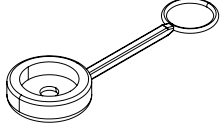
PART NUMBER	TYPE	WEIGHT	
231182	STR9-ELV	3.40 g (0.11 oz)	
230855	STR9-INF/AC	6.24 g (0.22 oz)	
			

STR9 GLARE CONTROL LOUVERS - 300 MM

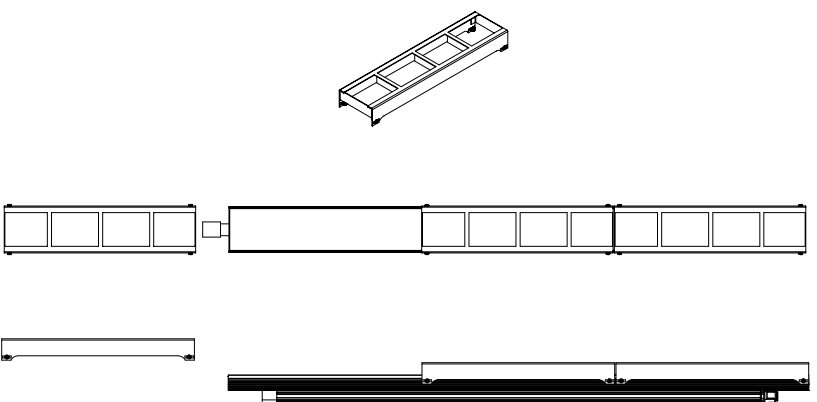
PART NUMBER	COLOR	WEIGHT	
122739	BLACK	0.08 kg (0.18 lbs)	

OPTIONAL ACCESSORIES

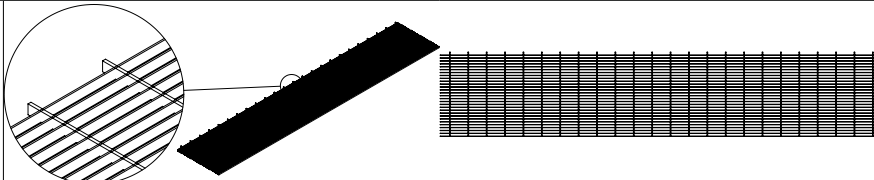
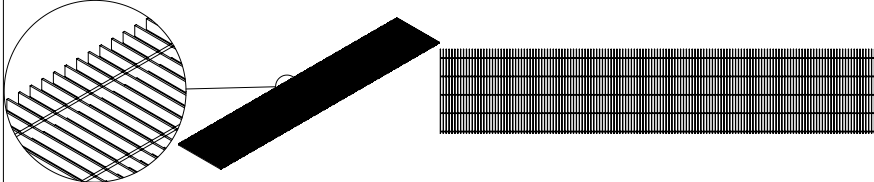
TYPE	COLOR	WEIGHT (Per 300mm)	
MLH - Micro Louver, Horizontal	BLACK	10 g 0.35 oz	 <p>*Please select option in the specification logic table if required. Item is factory installed only.</p>
MLV - Micro Louver, Vertical	BLACK	10 g 0.35 oz	 <p>*Please select option in the specification logic table if required. Item is factory installed only.</p>



ORDERING LOGIC: POWER SUPPLIES AND POWER DATA EQUIPMENT

ELV POWER DATA BOXES

FAMILY	OUTPUT VOLTAGE	POWER (Watts)		CONTROL INPUT	CONTROL OUTPUT	INPUT VOLTAGE	CONSTRUCTION
PDB	ELV (48V)	240W 320W	480W 640W	DALI/ 0~10V DMX	48V POWER & ZH DATA	120~277V AC	IP66 IP30

INFINITY POWER SUPPLIES IP66

PART NUMBER	DESCRIPTION	LENGTH	WIDTH	HEIGHT	WEIGHT	
G20337 G20338 G20341	PS-INF-3000-120VAC PS-INF-3000-208/240VAC PS-INF-3000-220/230/240VAC	260 mm 10.26 in	160 mm 6.30 in	91 mm 3.58 in	10.98 kg 24.2 lbs	

POWER-DATA CONVERTERS IP66

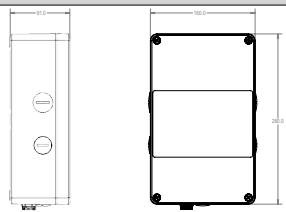
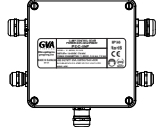
PART NUMBER	DESCRIPTION	LENGTH	WIDTH	HEIGHT	WEIGHT	
G20510 G20514 G20520 G20524	PDC-AC-120-1W+N+PE INPUT-1DMX PDC-AC-208~240-1W+N+PE INPUT-1DMX PDC-AC-277-1W+N+PE INPUT-1DMX PDC-AC-208~240-1W+N+PE INPUT-1DMX	260 mm 10.24 in	160 mm 6.30 in	91 mm 3.58 in	3.35 kg 7.39 lbs	
G20511 G20515 G20521 G20525	PDC-AC-120-1W+N+PE INPUT-DALI/0~10V PDC-AC-208~240-1W+N+PE INPUT-DALI/0~10V PDC-AC-277-1W+N+PE INPUT-DALI/0~10V PDC-AC-208~240-1W+N+PE INPUT-DALI/0~10V					
G20342 G20431 G20343	PDC-INF-1DMX PDC-INF-2DMX PDC-INF-DALI/0~10V	160 mm 6.30 in	160 mm 6.30 in	91 mm 3.58 in	2.06 kg 4.54 lbs	

POWER-DATA CONVERTERS IP30

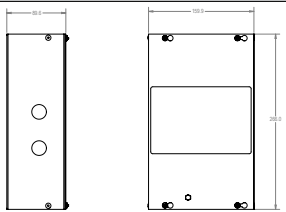
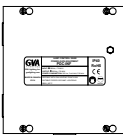
PART NUMBER	DESCRIPTION	LENGTH	WIDTH	HEIGHT	WEIGHT	
G20512 G20516 G20522 G20526	PDC-AC-120-1W+N+PE INPUT-1DMX PDC-AC-208~240-1W+N+PE INPUT-1DMX PDC-AC-277-1W+N+PE INPUT-1DMX PDC-AC-208~240-1W+N+PE INPUT-1DMX	266 mm 10.5 in	160 mm 6.30 in	90 mm 3.54 in	3.35 kg 7.39 lbs	
G00513 G20517 G20523 G20527	PDC-AC-120-1W+N+PE INPUT-DALI/0~10V PDC-AC-208~240-1W+N+PE INPUT-DALI/0~10V PDC-AC-277-1W+N+PE INPUT-DALI/0~10V PDC-AC-208~240-1W+N+PE INPUT-DALI/0~10V					
G20452 G20453 G20454	PDC-INF-1DMX PDC-INF-2DMX PDC-INF-DALI/0~10V	160 mm 6.30 in	160 mm 6.30 in	90 mm 3.54 in	2.06 kg 4.54 lbs	

POWER-DATA REPEATERS IP66

PART NUMBER	DESCRIPTION	LENGTH	WIDTH	HEIGHT	WEIGHT	
G20445 G20446	PDR-ELV-INF PDR-AC	160 mm 6.30 in	160 mm 6.30 in	91 mm 3.58 in	2.13 kg 4.70 lbs	

POWER-DATA REPEATERS IP30

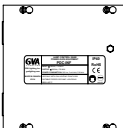
PART NUMBER	DESCRIPTION	LENGTH	WIDTH	HEIGHT	WEIGHT	
G20442	PDR-ELV-INF	160 mm 6.30 in	160 mm 6.30 in	91 mm 3.58 in	2.06 kg 4.54 lbs	



Color Changing Linear Wall Washing and Grazing LED Lighting

PRODUCT SPECIFICATION SHEET

TYPICAL SYSTEM DIAGRAM: ELV WITH CONTROL

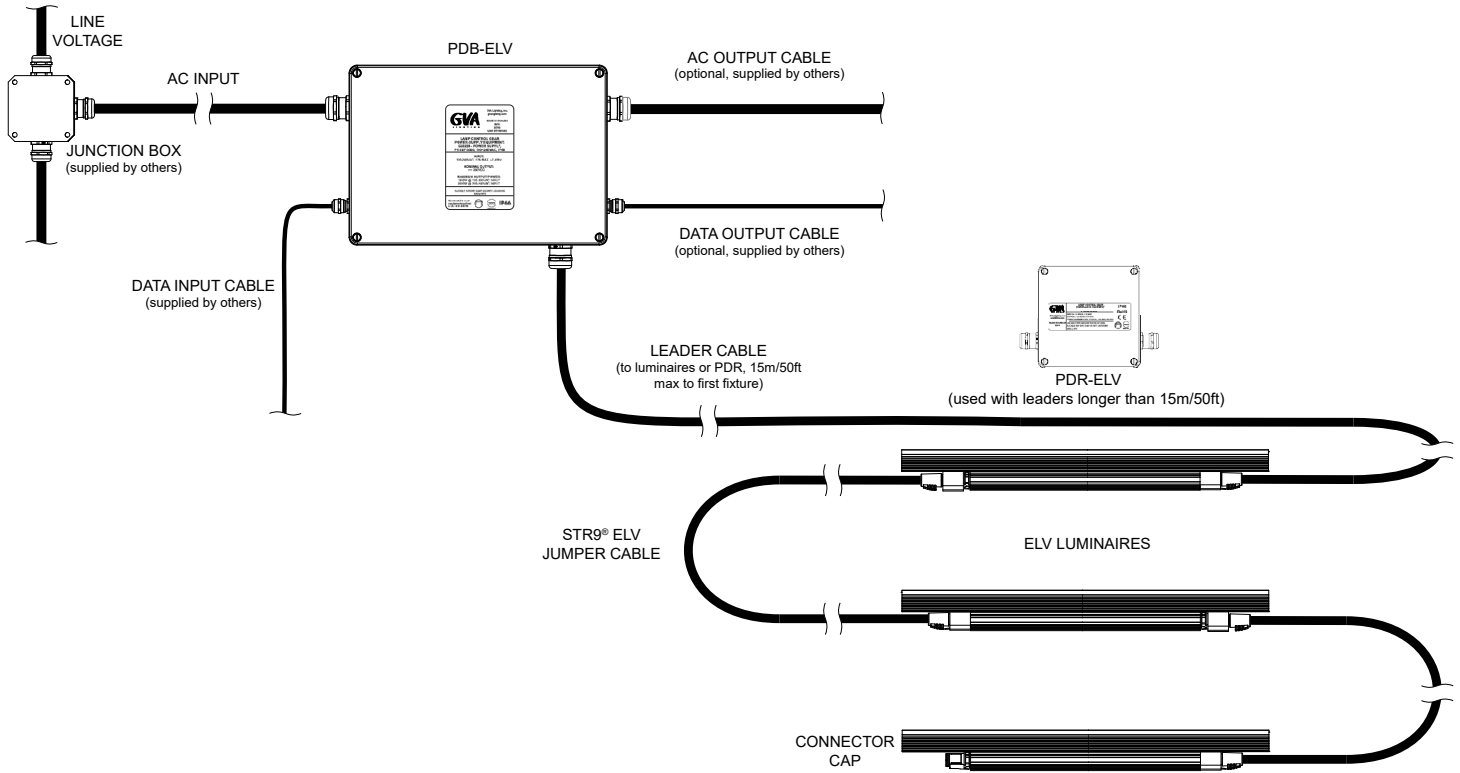

TYPICAL SYSTEM DIAGRAM: INFINITY WITH CONTROL

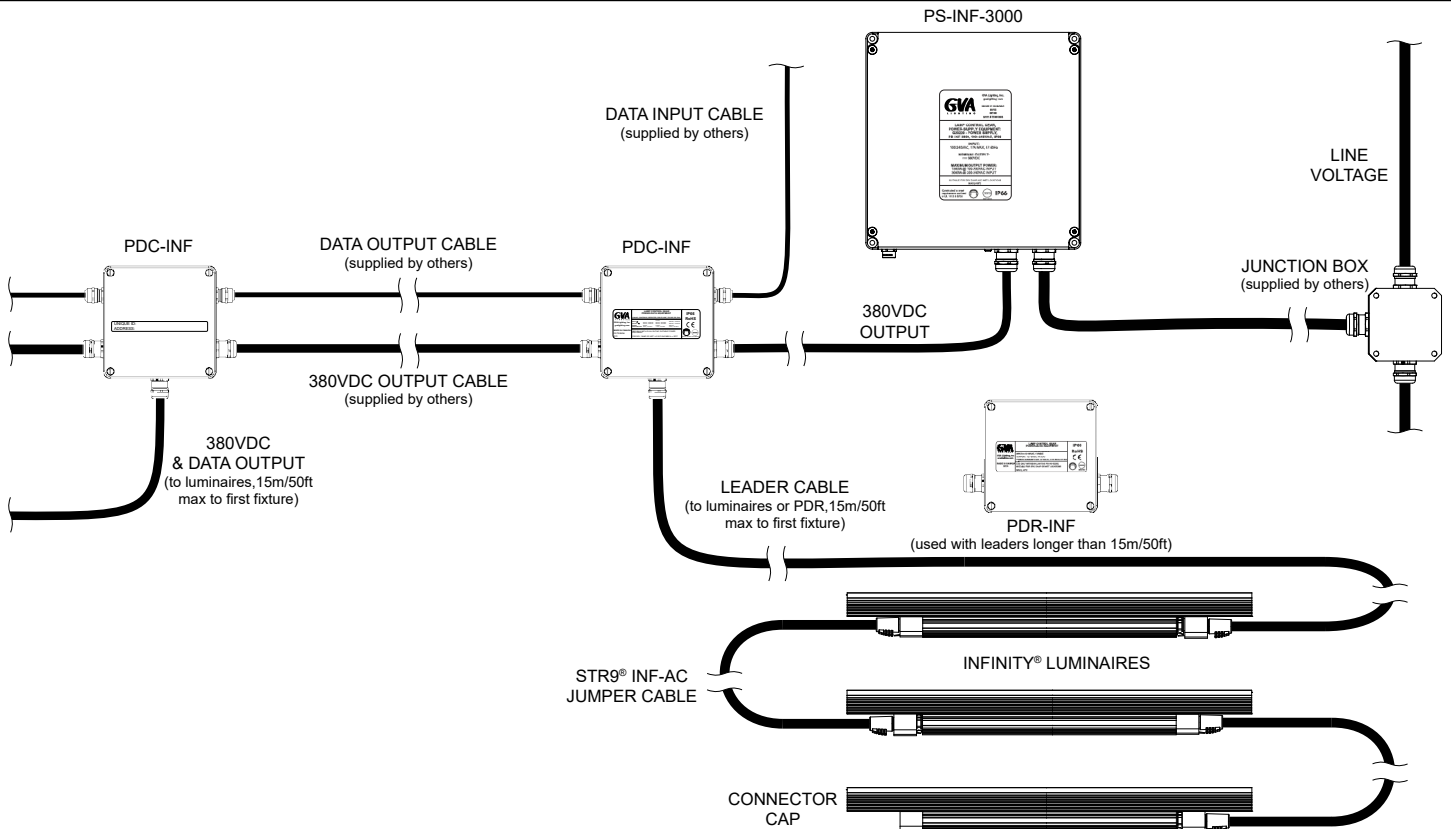



TYPICAL SYSTEM DIAGRAM: AC WITH CONTROL

