

RGBW Outer-Mixing Architectural Spot and Floodlight

PRODUCT SPECIFICATION SHEET

Color mixing outside of the fixture for the best performance, color mixing and highest punch.

DATE:	
TYPE:	
COMPANY:	
PROJECT:	

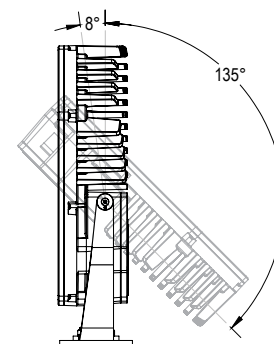
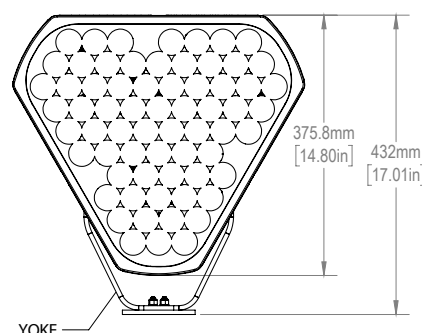
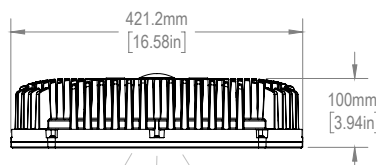

*SM200 bracket mounting option shown. See page 2 for more mounting options.

FEATURES:

- Ultra narrow 4.5° beam angle
- INFINITY® Technology compatible (INF)
- Built-in high temperature universal power supply (AC)
- Plug-and-play with STR9® luminaires
- Compact size, only 100mm (3.9in) in depth
- Weight of only 10kg (22lbs)
- Powder coating tested for corrosion resistance per ASTM B 117 salt spray resistance test @3000h

OPTIONS:

- Highly adjustable with 60° horizontal rotation and 143° vertical rotation
- Beam angles ranging from 4° to 85° with elliptical distribution options
- Custom LED color combinations available
- Optical accessories for glare control
- White, silver, and black standard powder coated body colors
- Custom body colors available on demand
- ELV (48VDC), INF (380VDC) and AC (120-277VAC) input options
- Range of bracket lengths and mounting options

SPECIFICATION LOGIC: FL200 OUTER MIXING

FAMILY	BODY COLOR	LED COLOR ²	OPTICS(FWHM)*	VOLTAGE	MOUNTING OPTION
FL200	WH - White Matte Powder Coated SR - Silver Matte Powder Coated BL - Black Matte Powder Coated CUST - Custom Color ¹	RGBW22K-OM¹ RGBW27K-OM RGBW30K-OM RGBW35K-OM RGBW40K-OM RGBW50K-OM RGBW65K-OM	4 - 4.5°x4.5° 5 - 5°x5° 7 - 7°x7° 8 - 8°x8° 10 - 10°x10° 20 - 20°x20° 40 - 40°x40° 60 - 60°x60° 75 - 75°x75° 85 - 85°x85° 10x40 - 10°x40° H 40x10 - 40°x10° V 10x60 - 10°x60° H 60x10 - 60°x10° V 30x60 - 30°x60° H 60x30 - 60°x30° V	ELV - 48VDC INF - 380VDC AC277 - 120-277VAC	SM70 - Low Profile Surface Mount 70mm ¹ 3G-SM120 - 3G Compliant Bracket SM200 - Surface Mount 200mm SM300 - Surface Mount 300mm ¹ SM400 - Surface Mount 400mm ¹ SM500 - Surface Mount 500mm ¹ SMXXX - Surface Mount Custom ² (specify length) TM200 - Tenon Mount 200mm ¹ AA-SM200 - 90 Degree Angle Adapter Bracket PM 6- Pole Mount (5.25-6in pole) ¹ PM 6.75 - Pole Mount (6-6.75in pole) ¹

PRODUCT CONFIGURATION

1. Non standard option and might require longer leadtime than usual. Contact factory for details.
 2. Custom color combinations are available from the color selection of FL100 Monochromatic. Contact GVA for more information.
 3. Bracket lengths longer than 500mm may not be available for some applications. Contact factory for details.

Nominal values are used. Actual measurements may differ slightly.

FL200 STANDARD MOUNTING BRACKET OPTIONS

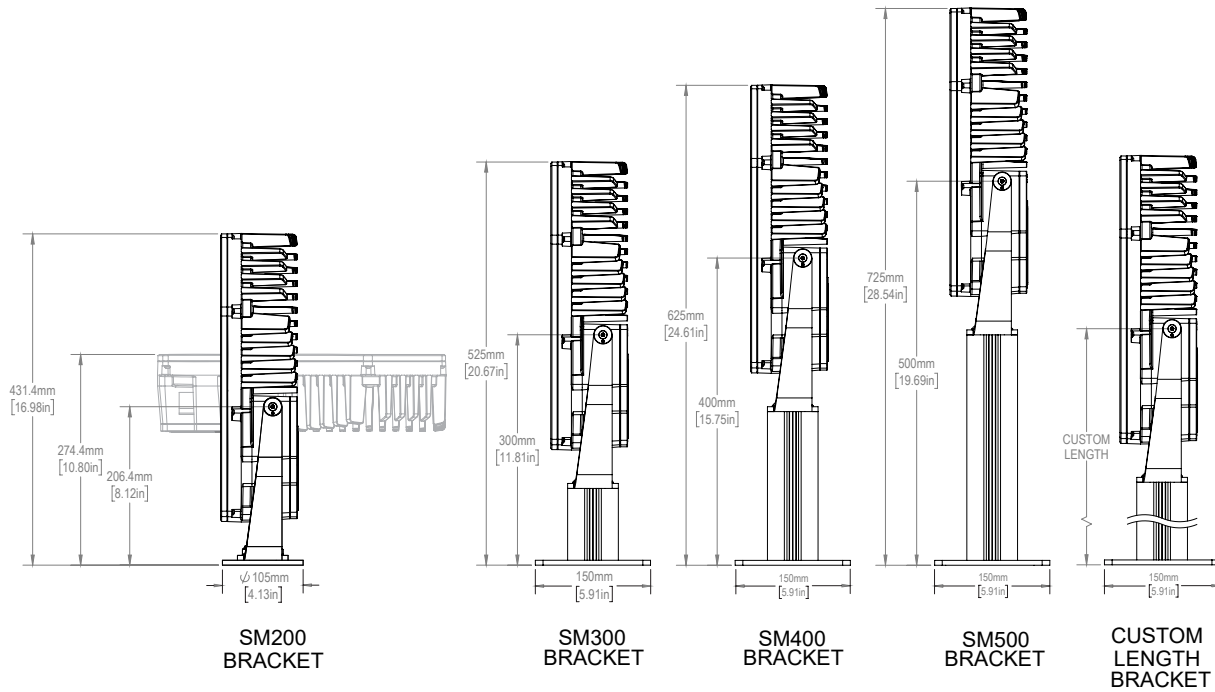

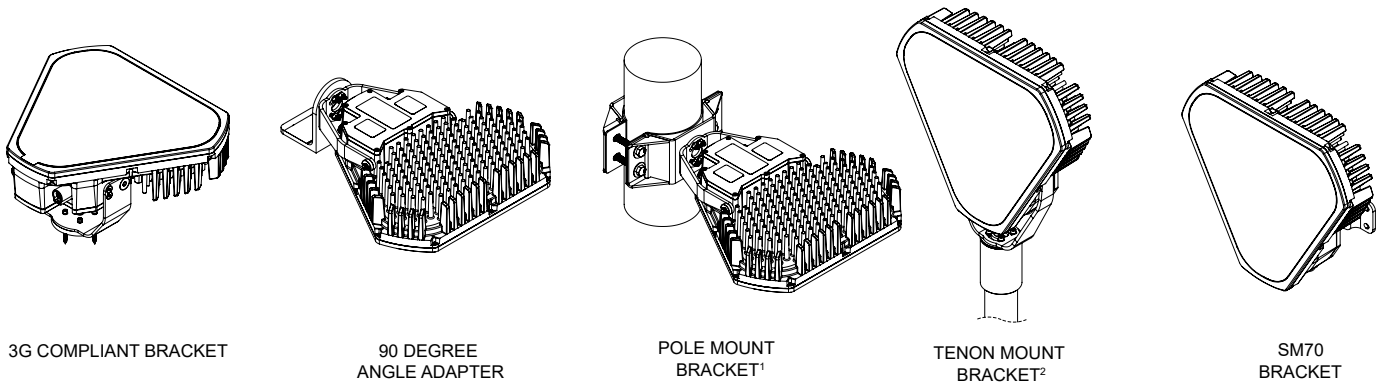

FL200 ADDITIONAL MOUNTING BRACKET OPTIONS

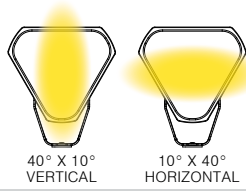

NOTE: 1. Available for pole diameters 5.25-6" (134-153mm) and 6-6.75" (154-171mm).
2. Available for tenon diameters 2-2.5" (50-64mm).

PRODUCT SPECIFICATIONS: FL200 RGBW-OM (OUTER MIXING)

ELECTRICAL	Rated Input Voltage	48VDC	380VDC	120-277VAC	
	Power Consumption (max.)	200W	210W	235W	
	Driver Type	N/A	N/A	Constant Voltage	
	Driver Loss	N/A	N/A	Power Factor 200VAC: max. 97% 120VAC: max. 99%	
	THD	N/A	N/A	200VAC: <17.5% 120VAC: <10%	
	Circuit Level Surge Protection	Transient-voltage-suppression diode ⁵		⁴	
OPTICAL	Light Source	69 x High Power LEDs			
	CRI	80 ¹			
	Output (typical) 4 ²	Color	Wave Length (nm)	Luminous Flux (lm)	
		Red	620	1,370	
		Green	525	3,367	
		Blue	470	1,019	
White - 4000K ³ All On			3,274 8,518		
Output (typical) 7 ²	Color	Wave Length (nm)	Luminous Flux (lm)		
	Red	620	1,340		
	Green	525	3,230		
	Blue	470	962		
	White - 4000K ³ All On		4,579 9,498		
Optics	High optical efficiency PMMA TIR Lens, Micro Lense Film, Tempered Glass Cover				
Beam Angle (FWHM)	4 (4.5°x4.5°), 5 (5°x5°), 7 (7°x7°), 8(8°x8°), 10 (10°x10°), 20 (20°x20°), 40 (40°x40°), 60 (60°x60°), 75 (75°x75°), 85 (85°x85°), 10x40 (10°x40°), 40x10 (40°x10°), 10x60 (10°x60°), 60x10 (60°x10°), 30x55 (30°x55°), 55x30 (55°x30°)				
Projected Lumen Maintenance	L70 > 60,000hrs @ Ta =50°C (122°F)				
CONTROL	Control Interface	DMX control through GVA's Power-Data Equipment			
PHYSICAL	Size (HxWxD)	421 x 376 x 100 mm (16.6 x 14.8 x 3.9 in)			
	Weight	10 kg (22 lbs)			
	Housing	ASTM B117 marine grade 3000h compliant powder coated, 6061 aluminum alloy			
	Rated Operation Temperature	-40°C (-40°F) to +50°C (122°F)			
CERTIFICATION & SAFETY	Environment	Dry, Damp or Wet Locations, 0-100% humidity			
	Listings	RoHS, REACH			
	IEC Classifications	Class I Luminaire			
				Constructed to meet requirements outlined in UL1598 & IEC60598	

1. Minimum 90 CRI also available.
 2. Luminous flux may vary by optical distribution.
 3. Warmer color temperatures typically have a lower lumen output.
 4. ± 2 kV line to line (differential mode) ± 2 kV line to common mode ground (tested to secondary ground) on AC power port, ±0.5 kV for outdoor cables based on IEC61000-4-5
 5. Supplementary protection recommended at the input of power supply
 6. IK10 available. Contact factory for details.

These figures are subject to change due to further development and innovations of LED light sources.

TYPICAL SYSTEM DIAGRAM: AC (WITH CONTROL)

NOTE: Length of leader cables and jumper cables directly affects the maximum number of fixtures in a single run.

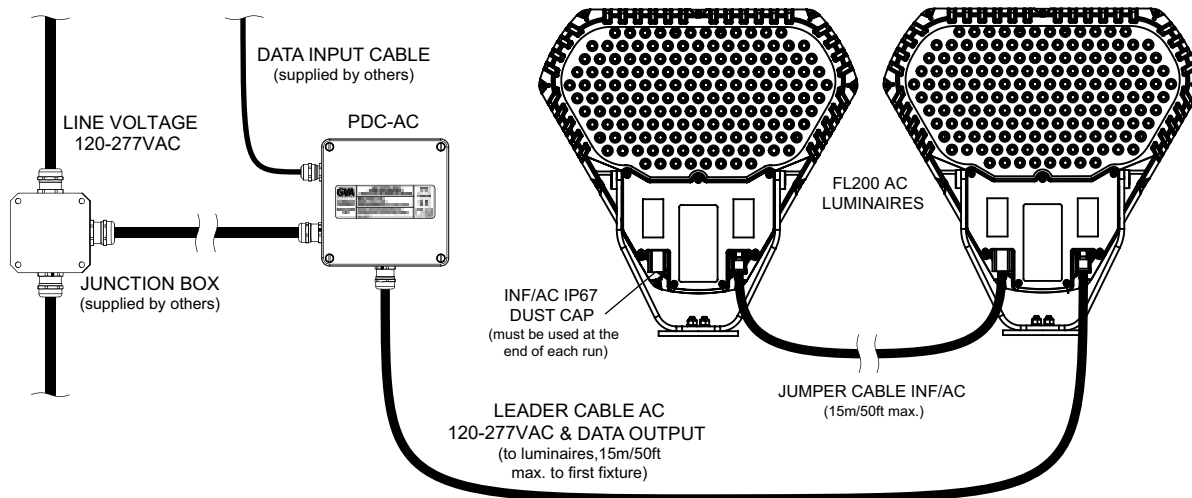

TYPICAL SYSTEM DIAGRAM: AC (WITH NO CONTROL)

NOTE: Length of leader cables and jumper cables directly affects the maximum number of fixtures in a single run.

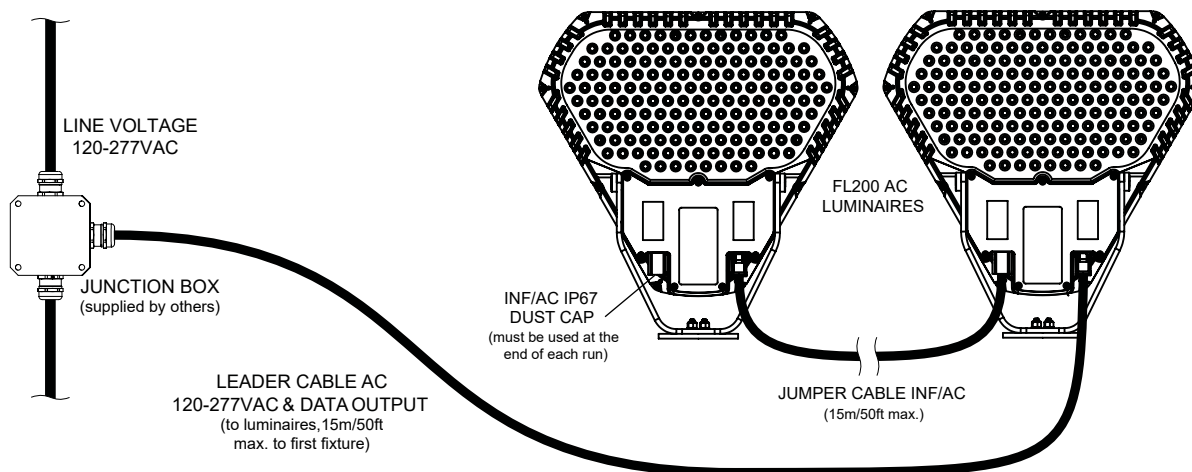

TYPICAL SYSTEM DIAGRAM: INFINITY® (WITH CONTROL)

NOTE: Length of leader cables and jumper cables directly affects the maximum number of fixtures in a single run.

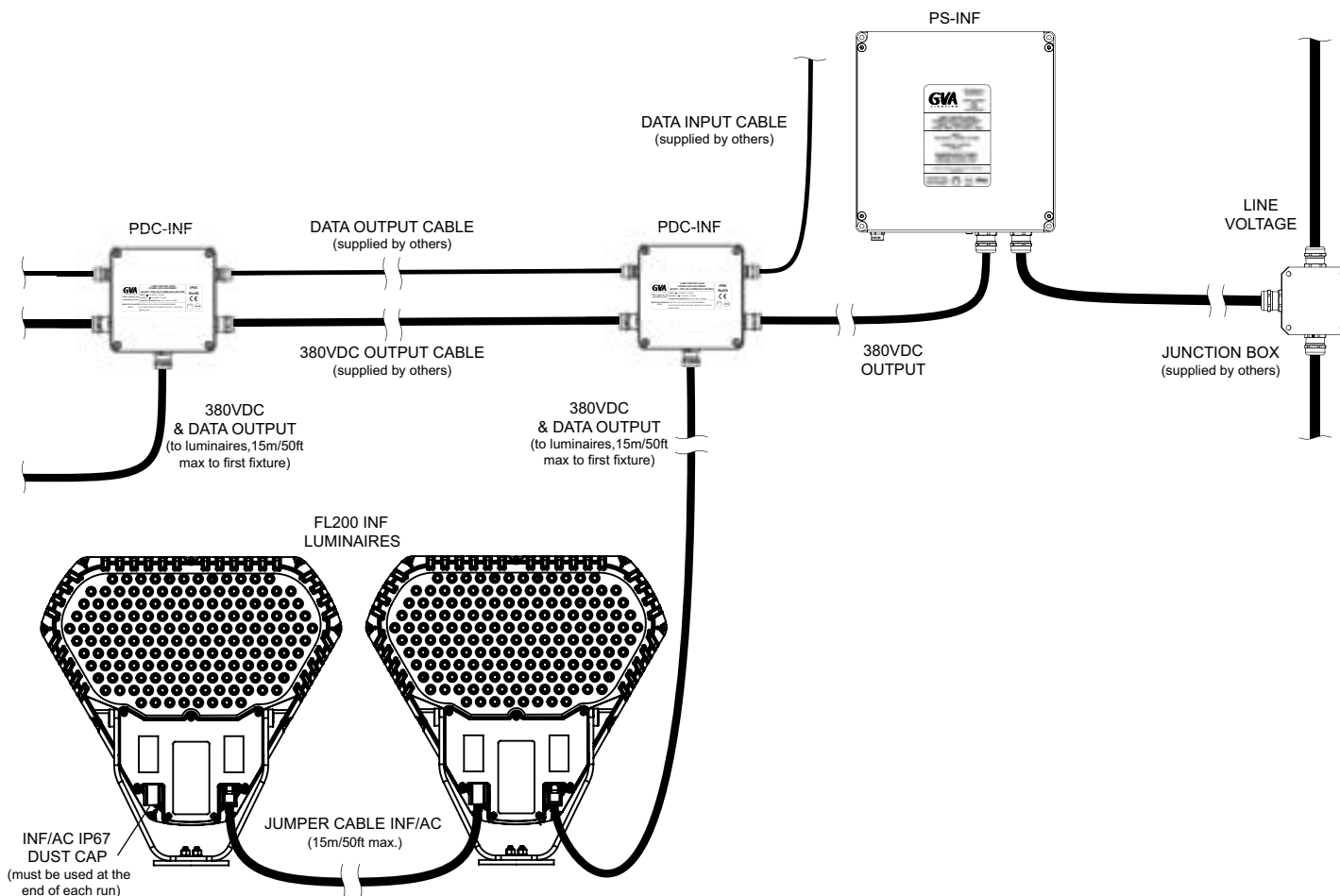

TYPICAL SYSTEM DIAGRAM: ELV (WITH CONTROL)

NOTE: Length of leader cables and jumper cables directly affects the maximum number of fixtures in a single run.

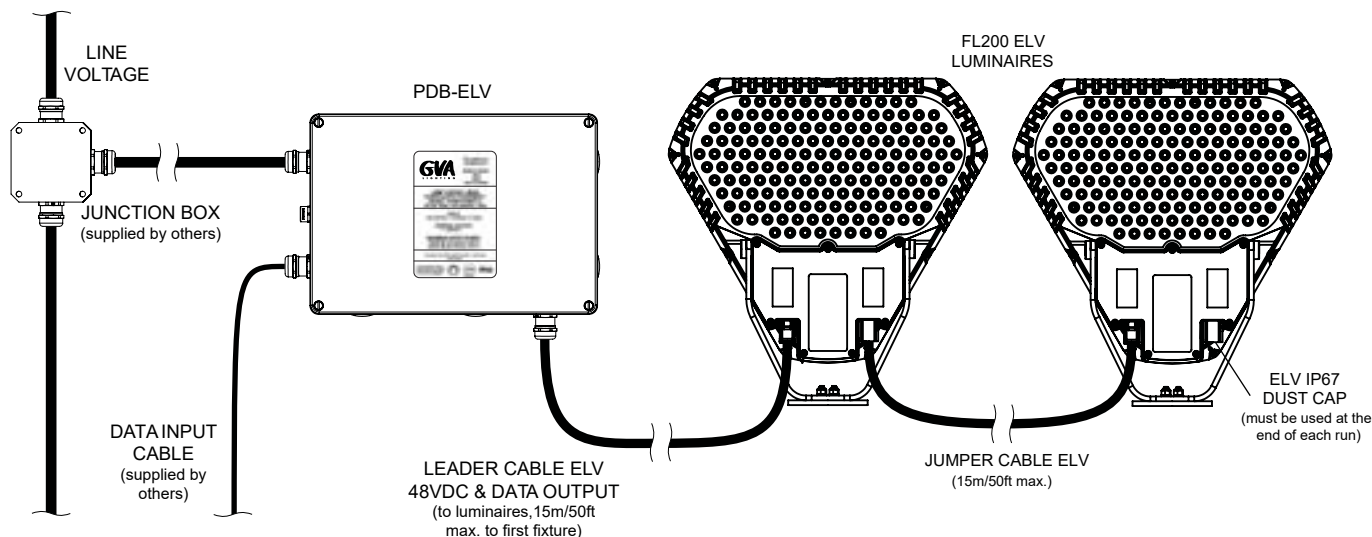

ORDERING LOGIC: ACCESSORIES

VISORS

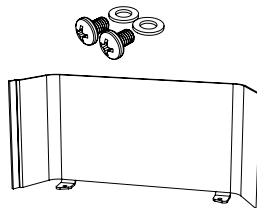
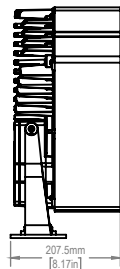
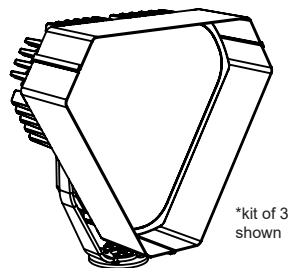

COLOR	KIT OF 1	KIT OF 2	KIT OF 3
White Matte	124792	124796	124800
Silver Matte	124793	124797	124801
Black Matte	122527	122530	122533
Custom Color	124795	124799	124803

* kit includes mounting hardware

BARN DOORS

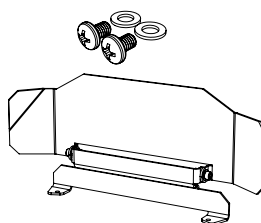
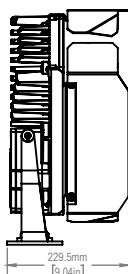
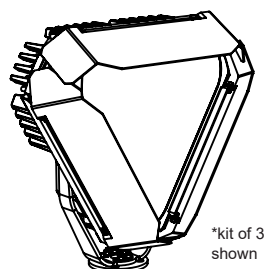

COLOR	KIT OF 1	KIT OF 2	KIT OF 3
White Matte	124704	124720	124736
Silver Matte	124705	124721	124737
Black Matte	122536	122539	122542
Custom Color	124707	124723	124739

* kit includes mounting hardware

ORDERING LOGIC: FL MOUNTING ACCESSORIES

FL LEADER CABLE ELV



NOMINAL LENGTH	PART NUMBER	WEIGHT
3.0 m (9 ft)	141481	420 g (0.93 lbs)
6.0 m (19 ft)	141484	815 g (1.80 lbs)
9.0 m (30 ft)	141487	1210 g (2.67 lbs)
15.0 m (50 ft)	141489	2000 g (4.41 lbs)
30.0 m (100 ft)	141492	3975 g (8.76 lbs)

FL LEADER CABLE INF



NOMINAL LENGTH	PART NUMBER	WEIGHT
3.0 m (9 ft)	141495	420 g (0.93 lbs)
6.0 m (19 ft)	141498	815 g (1.80 lbs)
9.0 m (30 ft)	141501	1210 g (2.67 lbs)
15.0 m (50 ft)	141503	2000 g (4.41 lbs)
30.0 m (100 ft)	141506	3975 g (8.76 lbs)

FL LEADER CABLE AC



NOMINAL LENGTH	PART NUMBER	WEIGHT
3.0 m (9 ft)	141509	420 g (0.93 lbs)
6.0 m (19 ft)	141512	815 g (1.80 lbs)
9.0 m (30 ft)	141515	1210 g (2.67 lbs)
15.0 m (50 ft)	141517	2000 g (4.41 lbs)
30.0 m (100 ft)	141520	3975 g (8.76 lbs)

FLJUMPER CABLE ELV

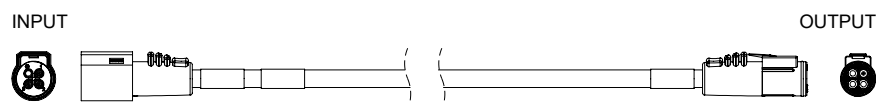

NOMINAL LENGTH	PART NUMBER	WEIGHT
0.3 m (1 ft)	141739	90 g (0.20 lbs)
0.6 m (2 ft)	141740	129 g (0.28 lbs)
0.9 m (3 ft)	141741	169 g (0.37 lbs)
1.2 m (4 ft)	141742	208 g (0.46 lbs)
1.5 m (5 ft)	141743	248 g (0.55 lbs)
1.8 m (6 ft)	141744	287 g (0.63 lbs)
6.0 m (20 ft)	141758	840 g (1.85 lbs)
9.0 m (30 ft)	141768	1235 g (2.72 lbs)

*Not all jumper lengths are shown. Lengths available in 300mm increments.

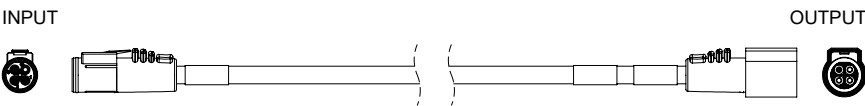
FL JUMPER CABLE INF AND AC			
	NOMINAL LENGTH	PART NUMBER	WEIGHT
<p>INPUT</p>  <p>OUTPUT</p> <p>*Not all jumper lengths are shown. Lengths available in 300mm increments.</p>	0.3 m (1 ft)	141789	90 g (0.20 lbs)
	0.6 m (2 ft)	141790	129 g (0.28 lbs)
	0.9 m (3 ft)	141791	169 g (0.37 lbs)
	1.2 m (4 ft)	141792	208 g (0.46 lbs)
	1.5 m (5 ft)	141793	248 g (0.55 lbs)
	1.8 m (6 ft)	141794	287 g (0.63 lbs)
	6.0 m (20 ft)	141808	840 g (1.85 lbs)
	9.0 m (30 ft)	141818	1235 g (2.72 lbs)

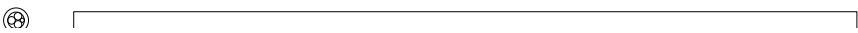
FL CABLE 3X14 AWG + 1X24 AWG			
	NOMINAL LENGTH	PART NUMBER	WEIGHT
 <p>*Raw cable cut to length. Please specify required length.</p>	Sold per m	280253	132 g (0.291lbs)

ORDERING LOGIC: COMMON COMPONENTS

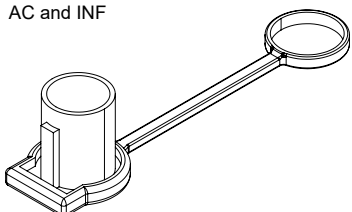
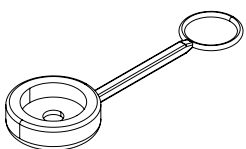
FL CONNECTOR DUST CAP, IP67 (MUST BE USED AT THE END OF EACH RUN)				
		TYPE	PART NUMBER	WEIGHT
<p>AC and INF</p> 	<p>ELV</p> 	FL-ELV	231182	3.40g / 0.11oz
		FL-AC and INF	230855	6.24g / 0.22oz